

Product Features



- Long life and better thermal management.
- High efficacy LED.
- Uniform and optimum light output and energy savings.
- Higher PF, Lower THD and Surge Protection.
- IP54



Electrical Specification	Rated Voltage (V)	220-240Vac
	Operating Voltage Range (V)	140-300Vac
	Operating Frequency (Hz)	50 +/-3%
	Driver Efficiency (%)	> 78
	System Power Consumption (W)± 10%	5W
	Inbuilt Surge Protection (kV)	2.5KV
	Electrical Insulation Class	Suitable for Class II
	Surge Protection (kV)(Inline SPD)	NA
Optical Specification	Light Source	LED
	Typ. Fixture Efficacy (LM/W)	Decorative light
	Color Temperature (K)	CDL / NDL / WDL
	CRI	70
	Diffuser / Optical material	Milky
	Beam Angle options	Diffused
Other Specification	Operating Ambient Temperature (°C)	0°C to + 45°C
	Housing	Powder coated Aluminum die cast
	Mounting Arrangement	Wall mounted
	IP rating	IP54

Model No.

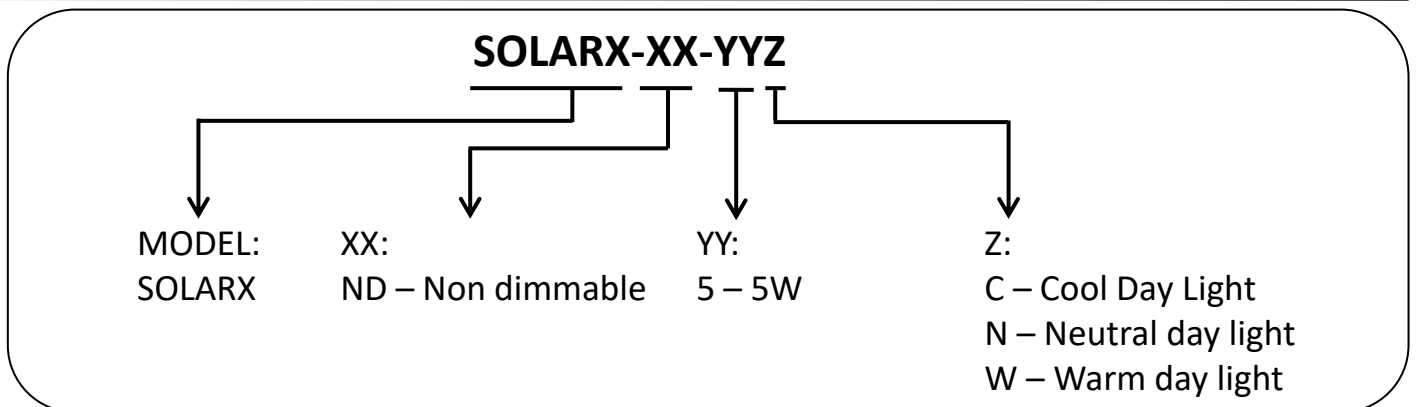

All features, functionality and other product specifications are subject to change without notice or obligation.